

EEE225: Analogue and Digital Electronics

Lecture IX

James E. Green

Department of Electronic Engineering

University of Sheffield

`j.e.green@sheffield.ac.uk`

This Lecture

- 1 Opamps with Frequency Dependent Feedback
 - Pole-Zero Circuits
 - Passive and Active First Order Circuits: Standard Forms
 - Passive and Active First Order Circuits: Low Pass with 'k'
 - Low Pass with 'k': Time and Frequency Domain Response
 - Passive and Active First Order Circuits: High Pass with 'k'
 - High Pass with 'k': Time and Frequency Domain Response
 - Pole-Zero Response
 - Passive PZ example: Getting the Standard Form...
 - Active PZ example: Getting the Standard Form...

- 2 Review

- 3 Bear

Pole-Zero Circuits

Pole-zero circuits aim to adjust the magnitude and phase response of an analogue system. They are constructed from the standard amplifier blocks but with Z_1 or Z_2 having some frequency dependent components - almost always capacitors. Inductors are too imperfect¹

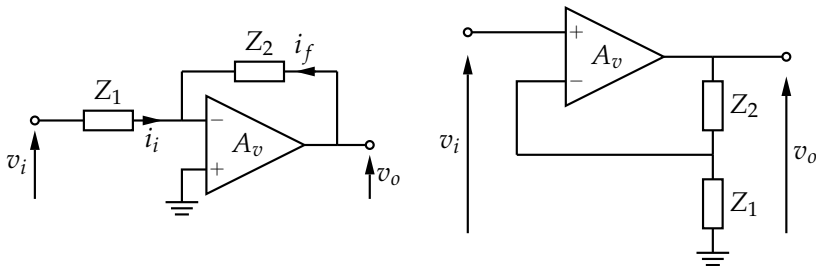

¹If an inductance is required, it may be manufactured with a capacitance and an opamp or two forming a gyrator, a kind of impedance transformer. See <http://sound.westhost.com/articles/gyrator-filters.htm> for examples.

Standard Forms

First order transfer functions fall into one of three standard forms,
low pass,

$$\frac{v_o}{v_i} = k \frac{1}{1 + s\tau} = k \frac{1}{1 + j \frac{\omega}{\omega_0}} = k \frac{1}{1 + j \frac{f}{f_0}} \quad (1)$$

high pass,

$$\frac{v_o}{v_i} = k \frac{s\tau}{1 + s\tau} = k \frac{j \frac{\omega}{\omega_0}}{1 + j \frac{\omega}{\omega_0}} = k \frac{j \frac{f}{f_0}}{1 + j \frac{f}{f_0}} \quad (2)$$

and pole zero,

$$\frac{v_o}{v_i} = k \frac{1 + s\tau_1}{1 + s\tau_0} = k \frac{1 + j \frac{\omega}{\omega_1}}{1 + j \frac{\omega}{\omega_0}} = k \frac{1 + j \frac{f}{f_1}}{1 + j \frac{f}{f_0}} \quad (3)$$

Passive and Active First Order: Low Pass with 'k'

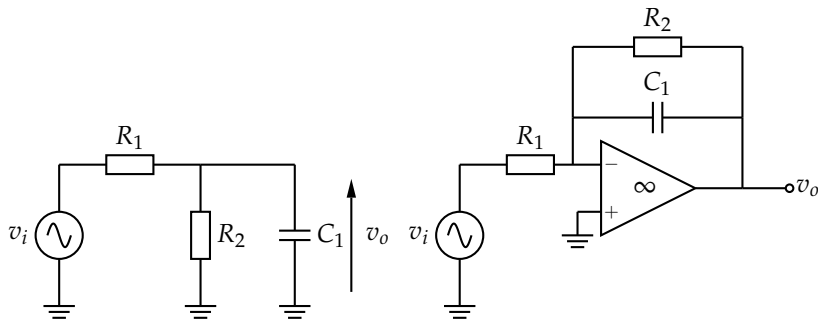

For the passive circuit:

$$\frac{R_2}{R_1 + R_2} \cdot \frac{1}{s C_1 (R_1 // R_2) + 1} \quad (4)$$

For the active circuit:

$$-\frac{R_2}{R_1} \cdot \frac{1}{s C_1 R_2 + 1} \quad (5)$$

They are not identical! but they are similar in the shape of the frequency response.

Time and Frequency Domain Response (Passive Version)

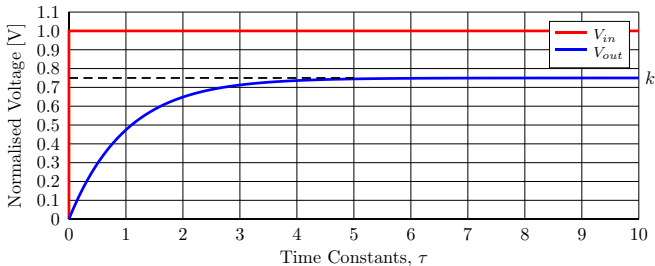
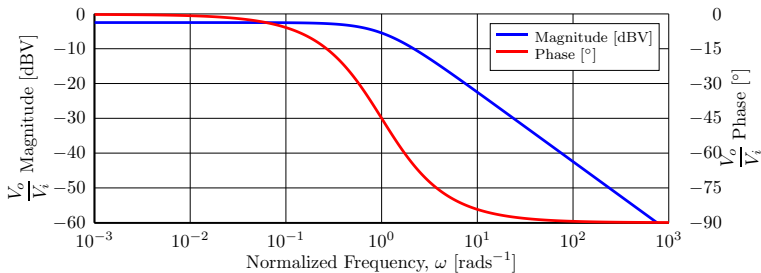

Passive and Active First Order: High Pass with 'k'

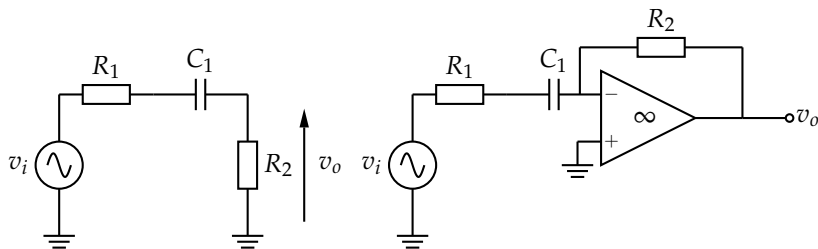

For the passive circuit:

$$\frac{R_2}{R_1 + R_2} \cdot \frac{s C_1 (R_1 + R_2)}{s C_1 (R_1 + R_2) + 1} \quad (6)$$

For the active circuit:

$$-\frac{R_2}{R_1} \cdot \frac{s C_1 R_1}{s C_1 R_1 + 1} \quad (7)$$

They are not identical! but they are similar in the shape of the frequency response.

Time and Frequency Domain Response (Passive Version)

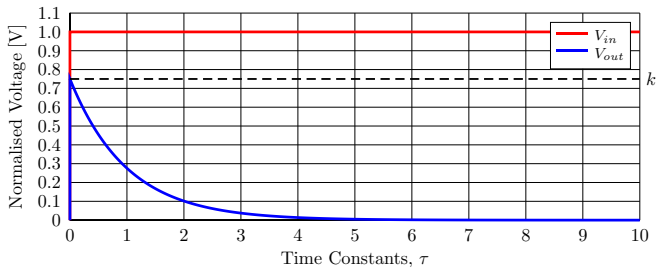
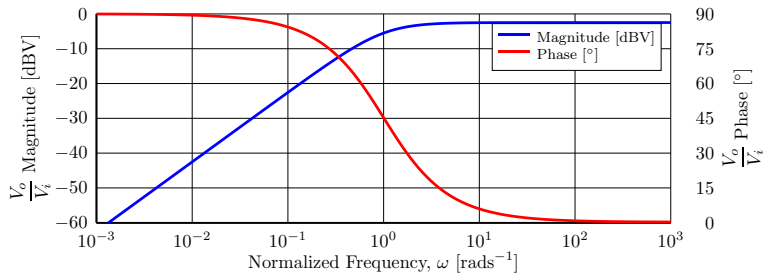

Passive and Active First Order: Pole-Zero (or Zero-Pole)

- The PZ system is the linear sum of HP and LP
- There is one pole and one zero.
- The pole may appear at a lower or higher frequency than the zero. The circuit is called pole-zero regardless!
- The pole determines the time constant, τ
- Occasionally may be called lead or lag compensator in control systems discussion.

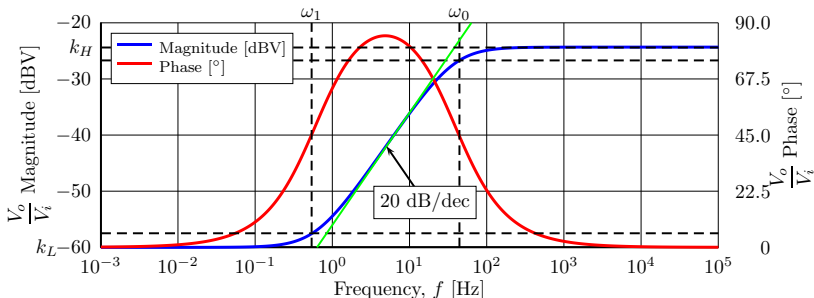

- There are two “gains” a low frequency (or DC, $f \rightarrow 0$) gain and a high frequency ($f \rightarrow \infty$) gain, k_L and k_H respectively.
- If zero frequency (ω_1) < pole frequency (ω_0) then $k_L < k_H$ and phase “leads” (+ ve) between the pole and zero. This is the case in the last slide.
- If the zero frequency (ω_1) > pole frequency (ω_0) then $k_L > k_H$ and phase “lags” (- ve) between the pole and zero.
- Magnitude slope tends to ± 20 dB/dec as the system is first order. Phase tends to $+90$ or -90 depending on PZ or ZP but often does not make it all the way.

Standard Forms:

frequency domain:

$$k \frac{1 + s\tau_1}{1 + s\tau_0} \quad (8)$$

Alternatively:

$$k \cdot \frac{1}{1 + s\tau_0} + k \cdot \frac{\tau_1}{\tau_0} \cdot \frac{s\tau_0}{1 + s\tau_0} \quad (9)$$

- The high frequency gain, $k_H = k \cdot \frac{\tau_1}{\tau_0}$ and $k = k_L$.

The step response depends on which of the pole or zero are at the lower frequency but for zero frequency $<$ pole frequency we have something that is broadly HP looking but v_{out} does not fall to zero, it tends towards k_L . For zero frequency $>$ pole frequency we have something broadly LP but also having a finite k_H .

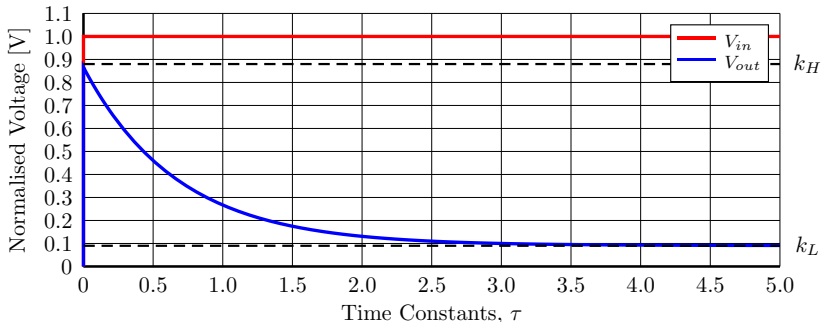

Passive Pole-Zero Example

Find the transfer function of the following PZ circuit.

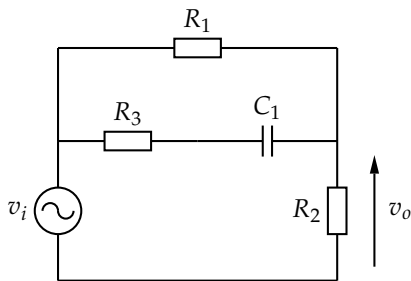

- Notice k is at the front and has no ω dependence.
- The s^0 (unity) coefficient is 1 in the numerator and denominator.
- The highest power of s is one.
- Always ask yourself, what is HF gain? what is LF gain? (good sanity check)...

$$k \cdot \frac{s \tau_1 + 1}{s \tau_0 + 1} = \frac{R_2}{R_1 + R_2} \cdot \frac{s C_1 (R_1 + R_3) + 1}{s C_1 \left(\frac{R_2 R_1 + R_2 R_3 + R_1 R_3}{R_1 + R_2} \right) + 1} \quad (10)$$

It's a potential divider with R_2 developing the output voltage,

$$v_o = \frac{R_2 v_i}{R_2 + R_1 // \left(R_3 + \frac{1}{s C_1} \right)} \quad (11)$$

Expanding,

$$\frac{v_o}{v_i} = \frac{R_2}{R_2 + \frac{R_1 \left(R_3 + \frac{1}{s C_1} \right)}{R_1 + R_3 + \frac{1}{s C_1}}} \quad (12)$$

Need to head towards $1 + s\tau$ on the bottom. Multiply top (numerator) and bottom (denominator) by $R_1 + R_3 + \frac{1}{s C_1}$

$$\frac{R_2 \left(R_1 + R_3 + \frac{1}{s C_1} \right)}{R_2 \left(R_1 + R_3 + \frac{1}{s C_1} \right) + R_1 \left(R_3 + \frac{1}{s C_1} \right)} \quad (13)$$

Multiplying out the brackets (expanding),

$$\frac{R_2 R_1 + R_3 R_2 + \frac{R_2}{s C_1}}{R_2 R_1 + R_3 R_2 + \frac{R_2}{s C_1} + R_1 R_3 + \frac{R_1}{s C_1}} \quad (14)$$

Multiplying top and bottom by $s C_1$,

$$\frac{(R_2 R_1 + R_3 R_2) s C_1 + R_2}{s C_1 R_2 (R_1 + R_3) + R_2 + R_1 R_3 s C_1 + R_1} \quad (15)$$

The unity term (coefficient of s^0) in the denominator is $R_1 + R_2$.
So lets divide top and bottom by $R_1 + R_2$ to get $s \tau + 1$ on the bottom.

$$\frac{s C_1 \frac{R_2(R_1+R_3)}{R_1+R_2} + \frac{R_2}{R_1+R_2}}{s C_1 \frac{(R_2 R_1+R_2 R_3+R_1 R_3)}{R_1+R_2} + 1} \quad (16)$$

Having found the desired form of the denominator we know the pole has a time-constant, $\tau_0 = C_1 \frac{(R_2 R_1 + R_2 R_3 + R_1 R_3)}{R_1 + R_2}$. The numerator is still not in the right form though as it must be $1 + s \tau_1$. We need to divide the numerator by the numerator's present coefficients of s^0 , which are $\frac{R_2}{R_1 + R_2}$. We can't change the denominator though, it is already in the desired form, so we are unbalancing our expression. k , the frequency independent gain, will restore balance by becoming the unity coefficients of the numerator, $\frac{R_2}{R_1 + R_2}$.

$$\frac{\frac{R_2}{R_1 + R_2} \cdot \left(s C_1 \cdot \frac{\cancel{R_2} (R_1 + R_3)}{\cancel{R_1} + \cancel{R_2}} + \frac{\cancel{R_2}}{\cancel{R_1} + \cancel{R_2}} \right)}{s C_1 \frac{(R_2 R_1 + R_2 R_3 + R_1 R_3)}{R_1 + R_2} + 1} \quad (17)$$

Performing the cancellations in (17) and bringing k outside of the fraction yields (10).

Active Pole-Zero Example

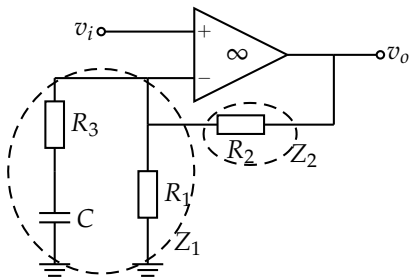

This is a standard non-inverting amplifier which has the gain expression:

$$\frac{v_o}{v_i} = \frac{Z_2 + Z_1}{Z_1} = \frac{R_2 + R_1 // \left(R_3 + \frac{1}{j\omega C} \right)}{R_1 // \left(R_3 + \frac{1}{j\omega C} \right)} \quad (20)$$

HF gain: (at HF, $C \rightarrow 0 \Omega$)

$$\frac{v_o}{v_i} = \frac{R_2 + (R_1 // R_3)}{R_1 // R_3} \quad (18)$$

LF gain: (at LF, $C \rightarrow \infty \Omega$)

$$\frac{v_o}{v_i} = \frac{R_2 + R_1}{R_1} \quad (19)$$

$$\frac{R_2 + \frac{R_1 \left(R_3 + \frac{1}{j\omega C} \right)}{R_1 + R_3 + \frac{1}{j\omega C}}}{\frac{R_1 \left(R_3 + \frac{1}{j\omega C} \right)}{R_1 + R_3 + \frac{1}{j\omega C}}} \quad (21)$$

Multiply top and bottom by $j\omega C$,

$$\frac{R_2 + \frac{R_1 (R_3 j\omega C + 1)}{1 + j\omega C (R_1 + R_3)}}{\frac{R_1 (R_3 j\omega C + 1)}{1 + j\omega C (R_1 + R_3)}} \quad (22)$$

Multiply top and bottom by $1 + j\omega C (R_1 + R_3)$,

$$\frac{R_2 (1 + j\omega C (R_1 + R_3)) + R_1 (1 + j\omega C R_3)}{R_1 (1 + j\omega C R_3)} \quad (23)$$

Collecting terms,

$$\frac{R_1 + R_2 + j\omega (R_2 R_1 + R_2 R_3 + R_1 R_3) C}{R_1 (1 + j\omega C R_3)} \quad (24)$$

Taking k outside, and comparing terms with the standard form,

$$\frac{R_1 + R_2}{R_1} \cdot \frac{1 + j\omega C \left(\frac{R_2 R_1 + R_2 R_3 + R_1 R_3}{R_1 + R_2} \right)}{1 + j\omega C R_3} \equiv k \frac{1 + j\omega \tau_1}{1 + j\omega \tau_0} \equiv k \frac{1 + j\frac{f}{f_1}}{1 + j\frac{f}{f_0}} \quad (25)$$

$$f_1 = \frac{R_1 + R_2}{2\pi C (R_1 R_2 + R_2 R_3 + R_1 R_3)} \quad (26)$$

$$f_0 = \frac{1}{2\pi C R_3} \quad (27)$$

$$k = \frac{R_1 + R_2}{R_1} \quad (28)$$

when $\omega \gg 2\pi f_1$ and $2\pi f_0$ (i.e. at high frequencies), the 1s are negligible compared to the f terms,

$$\left| \frac{v_o}{v_i} \right| = k \left| \frac{\cancel{1}^2 + \left(\frac{f}{f_1}\right)^2}{\cancel{1}^2 + \left(\frac{f}{f_0}\right)^2} \right|^{\frac{1}{2}} = k \frac{f}{f_1} = k \frac{f_0}{f_1} \quad (29)$$

$$k \frac{f_0}{f_1} = \frac{\cancel{R_1 + R_2}}{R_1} \cdot \frac{\frac{1}{2\pi C R_3}}{\frac{\cancel{R_1 + R_2}}{2\pi C (R_1 R_2 + R_2 R_3 + R_1 R_3)}} \quad (30)$$

$$\frac{R_1 R_2 + R_2 R_3 + R_1 R_3}{R_1 R_3} = \frac{R_1 R_2 + R_2 R_3}{R_1 R_3} + 1 \quad (31)$$

$$R_2 \left(\frac{R_1 + R_2}{R_1 R_3} \right) + 1 = \frac{R_2}{R_1 // R_3} + 1 = \frac{R_2 + R_1 // R_3}{R_1 // R_3} \quad (32)$$

Compare (32) with (18). At low frequencies, $\omega \ll 2\pi f_1$ and $2\pi f_0$, the 1s dominate the f terms, and gain $\rightarrow k$.

Review

- Revisited some EEE117 material on frequency and time domain response of first order LP and HP systems.
- Noted that the Pole-Zero circuit is a combination of the LP and HP first order circuits.
- Enumerated some key points about the pole zero circuit/system including:
 - There is one pole and one zero
 - The pole can be found at a lower frequency than the zero or *vice versa*.
 - The pole determines the time constant, τ .
 - sometimes called “lead/lag compensation circuits”.
- Examined a passive network pole zero circuit similar to EEE117
- Examined an active, opamp based, pole zero circuit.

