

# EEE118: Electronic Devices and Circuits

## Lecture VIII

James E. Green

Department of Electronic Engineering

University of Sheffield

`j.e.green@sheffield.ac.uk`

## Review

- 1 Noted the existence of two useful - in terms of designing circuits and understanding them - programs for numerical and analytical simulation of electronic circuits.
  - LTSpice - Numerical simulation of linear and non-linear circuits
  - QsapecNG - Analytical (i.e. algebraic) simulation of linear circuits
- 2 Introduced the idea of linear power supplies
- 3 Briefly discussed some differences between single phase and three phase supplies
- 4 Considered the half wave rectifier in detail
- 5 Used a peak detector circuit to smooth the output voltage of the peak detector
- 6 Developed a simple model to find a suitable capacitor value for a power supply filter

# Outline

- 1 Full Wave Rectifier
- 2 Full Wave Bridge Rectifier
- 3 Smoothing a Full Wave Rectifier
- 4 Three Phase Full Wave Rectifiers
- 5 Linear Power Supplies: Summary
- 6 Stabilisation and Regulation of DC Power Supplies
- 7 Zener Diode Linear Shunt Regulator
- 8 Review
- 9 Bear

## Full Wave Rectifier

The full wave rectifier is essentially the combination of two half wave circuits.

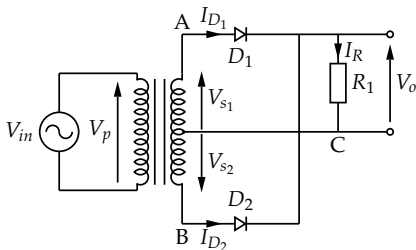

In this circuit  $V_{s1}$  and  $V_{s2}$  are  $180^\circ$  out of phase i.e. when node A is at  $\sqrt{2} V_s$ , node B is at  $-\sqrt{2} V_s$ .  $V_{s1}$  and  $D_1$  form one half wave rectifier and  $V_{s2}$  and  $D_2$  form another. The outputs of these two half wave rectifiers are combined before being applied to the load.

Because of the  $180^\circ$  phase shift between  $V_{s1}$  and  $V_{s2}$ ,  $V_{s2}$  and  $D_2$  are active when  $V_{s1}$  and  $D_1$  are not active. Therefore there is a current flowing in  $R_1$  for every half cycle

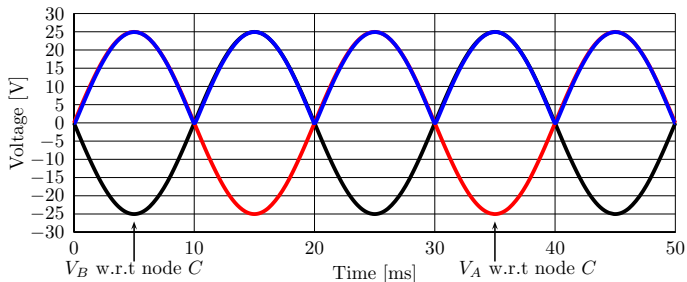

Blue:  $V_o$ , Black:  $V_{s1}$  Red:  $V_{s2}$

If the diodes in the full wave circuit were reversed,  $V_o$  would be negative, (i.e. upside down). Is it possible to add reversed versions of  $D_1$  and  $D_2$  to nodes  $A$  and  $B$  in the full wave circuit? Could this then provide a simultaneous positive and negative output with respect to node  $C$ ?

This circuit consists of four half wave rectifiers connected to rectify the **full wave**.

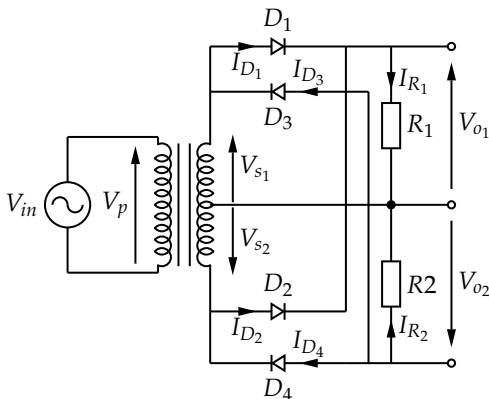

$V_{s1}$  and  $V_{s2}$  face opposite directions because the transformer centre tap is the reference. Re-arranging this circuit the standard version of this circuit is obtained, where the diodes are drawn to form a *bridge*. This circuit is known as a **full wave bridge rectifier**.

## Full Wave Bridge

In these figures the diodes  $D_1$  and  $D_2$ ,  $R_1$  and  $V_{o1}$  are exactly the same as the simple full wave (two diode) case. The outputs from the bridge rectifier can be used in various ways. If node  $C$  is the reference point, node  $D$  is a positive output voltage and node  $E$  is a negative output.

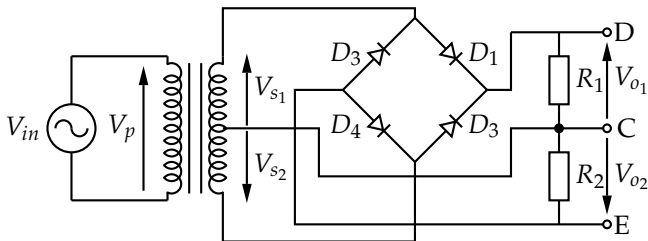

Or if node  $E$  is the reference point, both nodes  $C$  and  $D$  are positive with  $D$  having twice the magnitude of node  $C$ .

## Applications

Yet another possibility is that node  $D$  is the reference and both  $C$  and  $E$  are negative with  $E$  having twice the magnitude of  $C$ .

### Applications

- A positive and negative output with respect to node  $C$ . This is used extensively in analogue systems where bipolar signals centred on zero are used, e.g. audio amplifiers. It is often called a “centre zero” power supply.
- A single output of node  $D$  with respect to node  $E$ . This is the low cost version e.g. for a car battery charger. In this case the connection between the centre tap of the transformer and node  $C$  is often omitted.



## Smoothing a Full Wave Rectifier

- Smoothing a full wave rectifier output is very similar to smoothing a half wave circuit. The main difference is that the half wave rectifier charges the smoothing capacitor *once per input cycle*, whilst a full wave rectifier charges the smoothing capacitor *twice per input cycle*.
- In all other respect the behaviour is the same.
- Because of this the prior equations can be used to choose a capacitor to meet the ripple voltage requirements or to estimate the ripple given the circuit values and operating conditions.
- When calculating capacitances for full wave power supplies remember that the capacitance is replenished at 100 Hz. Not 50 Hz as is the case with the half wave circuit.

## Three Phase Full Wave Rectifiers

- Most power systems that handle more than a few kW are three phase systems
- A three phase power system has three live conductors instead of the single live conductor in most domestic systems
- The three live conductors carry power at the same frequency, but are displaced in phase from one another by  $120^\circ$ .
- The main advantage of three phase is that power is continuously available and never drops to zero. Two phases are always have non-zero voltage at any time.
- The phase currents tend to cancel each other, summing to zero in the case of a linear balanced load. This makes it possible to eliminate or reduce the size of the neutral conductor

- All the phase conductors carry the same current and so can be the same size, for a balanced load.
- Power transfer into a linear balanced load is constant, which helps to reduce generator and motor vibrations.
- Three-phase systems can produce a magnetic field that rotates in a specified direction, which simplifies the design of some types of electric motor/generator.

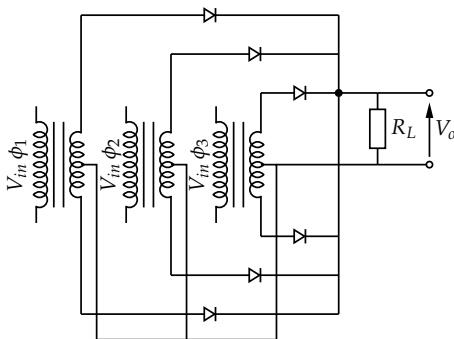

- There is a large DC output voltage,  $V_{DC} = 0.955 V_{s_{pk}}$ , in the un-smoothed output waveform.
- The peak to peak ripple voltage of the un-smoothed output waveform is  $0.133 V_{s_{pk}}$ . This is compared to a value of  $V_{s_{pk}}$  for single phase full wave and half wave rectifier circuits.

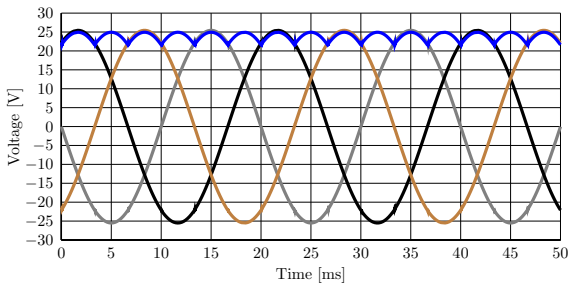

- The fundamental frequency of the ripple is six times the input frequency e.g. 300 Hz for 50 Hz input. This should be compared to twice the input frequency for single phase half wave and full wave rectifiers respectively.
- Because of this, the un-smoothed three phase output is significantly “better” than single phase.
- For many three phase applications it is therefore not necessary to use smoothing.
- Where smoothing is needed, it is easier to achieve than in single phase circuits because
  - The intrinsic ripple voltage is smaller  $0.133 V_{s_{pk}}$  vs.  $V_{s_{pk}}$ .
  - The ripple frequency is higher, so the time between replenishing the smoothing capacitor is reduced. Consequently, for a given ripple specification the smoothing capacitance can be a smaller value. High capacitance electrolytics are expensive especially when higher voltage specification is required e.g. EVOX RIFA 6800  $\mu\text{F}$ , 385 V, £84.80 + VAT

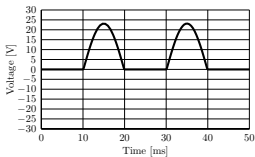
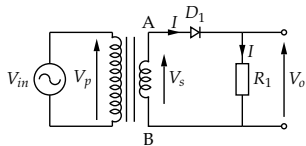
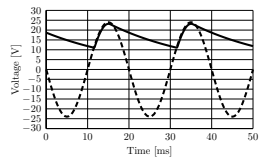
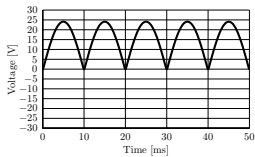
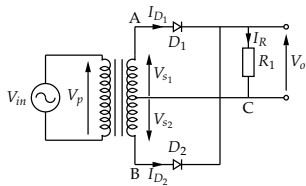
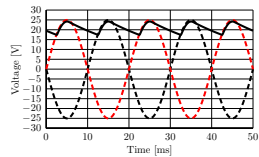
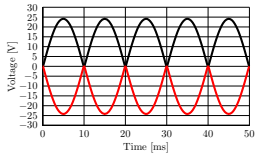
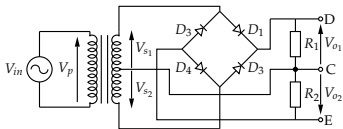
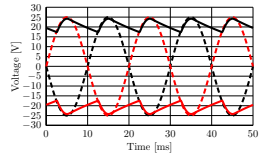
—  $V_o$ - - -  $V_A$  —  $V_o$ —  $V_o$ - - -  $V_A$  - - -  $V_B$  —  $V_o$ —  $V_{o1}$  —  $V_{o2}$ - - -  $V_{s1}$  - - -  $V_{s2}$  —  $V_{o1}$  —  $V_{o2}$

## Stabilisation and Regulation of DC Power Supplies

- The output from a rectifier and smoothing circuit is not often of sufficient quality to supply an electronic circuit directly. (although exceptions do exist in e.g. power electronics / electrical machines).
- The effects of finite supply and transformer impedance make it difficult accurately to predict the DC component in the output waveform, and make the DC and ripple components of the power supply dependent on the load.
- The supply voltage can vary. Although we say a 240 V RMS supply in the UK the regulation states that this can have a large tolerance. The current regulation is that it should be  $230\text{ V} \pm 10\%$  (207 - 253 V). This just covers the same voltage range as continental Europe. The utility companies use this tolerance to manage the load and ensure the frequency specification is maintained.

- The ripple voltage can also be a problem, introducing noise (hum) into circuits. To have a very small ripple voltage requires high smoothing capacitance, which is expensive and bulky - often impractical.

To mitigate the short-comings of these circuits **regulation** and **stabilisation** are required.

### Stabilisation

The process of making the output independent of changes in utility supply voltage.

### Regulation

The process of making the output voltage independent of the load current.

Regulation and stabilisation are achieved simultaneously by circuits called **regulator circuits** of which there are two types **series regulators** and **shunt regulators**.



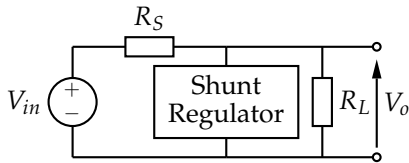
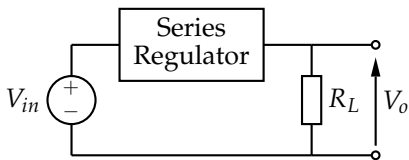

These types can be further subdivided depending on their principle of operation. In EEE118 only the [Zener diode shunt linear regulator](#) will be covered. See EEE340 or the EEE118 course books for a more general appraisal. In both series and shunt [linear regulators](#) the lowest value of the unregulated DC input voltage must be greater than the required output voltage by a defined margin which is dependant on the particulars of the circuit design. In prior times rectification, regulation and stabilisation was achieved by other methods <sup>1,2,3</sup>.

<sup>1</sup>Smith, F. L. (editor), *Radiotron Designers Handbook*, RCA Victor, 4th edition, 1954, Chapters 30 – 34

<sup>2</sup>Terman, F. E., *Electronic and Radioengineering*, McGraw Hill, 4th edition, 1957, Chapter 20

<sup>3</sup>Williams E., *Thermionic Valve Circuits*, Sir Isaac Pitman & Sons, 4th edition, 1961, pp. 237 onwards

## Series Regulator Operation

The series regulator restricts the flow of current from the input to the output in such a way as to maintain a constant  $V_o$  across the load.

## Shunt Regulator Operation

The shunt regulator restricts or increases its own current demand in such a way as to maintain a constant voltage across itself by dropping a varying voltage across  $R_s$ . Since the regulator is in parallel with the load, the load voltage is regulated as well.

To construct a shunt regulator an electronic device or component is required which can draw a varying current while dropping as, nearly as possible, a constant voltage. Essentially a **current sink**.

## Zener Diode Linear Shunt Regulator

The simplest form of shunt regulator is constructed with a Zener diode. Where the Zener diode acts as a variable current sink. The Zener diode is a pn junction diode in which both N and P regions are highly doped. Their forward bias characteristics are similar to “normal” diodes but their reverse bias characteristics are engineered so that the diode will break down at a specified voltage. This breakdown behaviour is achieved by virtue of the high doping which gives rise to a **large peak electric field** when the diode is reverse biased. The high doping is also responsible for the very **thin depletion width**. Depending on the specified breakdown voltage the Zener diode will either breakdown by **quantum mechanical tunnelling** ( $V_B < 4 V$ ), by **impact ionisation** ( $V_B > 6 V$ ) or by both processes ( $4 V < V_B < 6 V$ ).

The breakdown gives the Zener diode a very abrupt or “sharp” breakdown characteristic. When broken down a small increase in the applied voltage will yield a large increase in current.

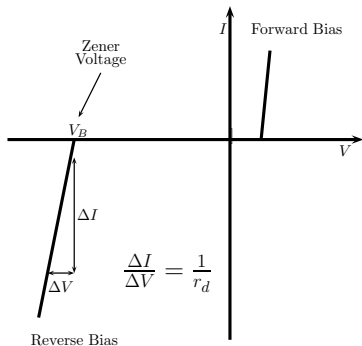

Note that it is assumed that the I-V curve in the breakdown region is linear. This is not very realistic, so generally the dynamic resistance,  $r_d$  is thought of as the tangent of the curve at a particular breakdown current.

Under normal Zener operation in a shunt regulator the dynamic resistance varies in order to conduct enough current through the diode so that the voltage across the load is held constant by dropping the rest of the supply voltage across  $R_s$ .

## Review

- Considered full wave and bridge rectifiers as an extension to the half wave principle
- Noted that in the full wave circuit the smoothing capacitor is replenished at double the line frequency
- Observed that the output voltage polarity available is only a function of where the reference is placed
- Discusses the differences between three phase and single phase systems more fully.
- Concluded the section on linear power supplies with a review of the circuits.
- Introduced [stabilisation](#) and [regulation](#) of power supplies.
- Briefly noted the existence of [series](#) and [shunt](#) regulators
- Discussed the usefulness of the Zener diode as a shunt regulator

