

EEE118: Electronic Devices and Circuits

Lecture III

James E. Green

Department of Electronic Engineering

University of Sheffield

`j.e.green@sheffield.ac.uk`

Last Lecture: Review

- Finished discussed of **Passive Components** with inductors their physical construction, relative price and performance.
- Considered perfect and imperfect voltage and current sources
- **Perfect current sources have infinite parallel resistance**
- **Perfect voltage sources have zero series resistance.**
- Introduced the **Thévanin** and **Norton** theorems of source transformation. And gave a simple example of each.
- Introduced the **Superposition** theorem and gave a simple example.
- Considered the conditions required for **maximum power transfer** from a Thévanin source ($R_L = R_T$). This result will be used again in EEE225 when studding electronic noise. Could you derive for Norton on your own?

Outline

- 1 Terminology
 - Active and Passive Components, Bias and Signals
- 2 Diodes
 - Forward Bias Characteristics
 - Reverse Bias Characteristics
- 3 Conduction State Definitions
- 4 General Method for Diode Conduction State Problems
 - Series Resistance + Diode Analysis
- 5 A Comprehensive Conduction State Example
- 6 Review
- 7 Bear

Signal

A voltage, current or other measurable quantity which carries useful information.

Bias

A constant voltage or current which is used to set up favourable quiescent conditions in a circuit containing active components.

Passive Component

One which requires no external energy (other than the signal) to operate.

Active Component

One which requires external energy (bias) to set the quiescent conditions so that the circuit containing the active component(s) will perform some useful function.

Diodes

- A diode is a **two terminal electronic device** that allows **current flow in one direction only**.
- Diodes are **non-linear** circuit elements. The current through a diode is not *linearly* proportional to the voltage across it.
- Diodes are **active components**.
- Diodes can be produced using several technologies, including thermionic valves, semiconductor-metal junctions and semiconductor-semiconductor junctions.



By far the most common is the **silicon p-n junction diode**. It is formed by two pieces of semiconductor, one doped **n-type** and another **p-type** in **close metallurgical contact**. The **n-type** material is doped with impurities to add **additional electrons** and the **p-type** doped to add **additional holes**. An alloy of metals are deposited on the surfaces of the **n** and **p-type** semiconductors. Fine gold or aluminium wires are bonded to the contacts and to the package body. The package is **hermetically sealed**.

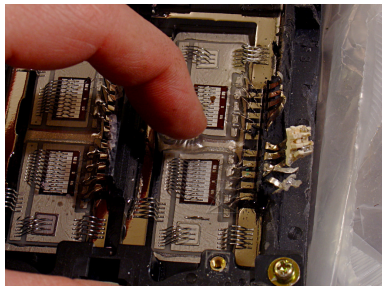
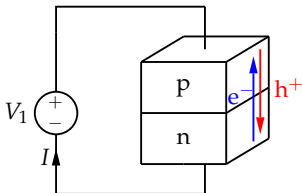

Forward Bias Characteristics

Under **forward bias** the diode obeys the Shockley - or **diode equation** - $I = I_0 \left(\exp \left(\frac{qV}{kT} \right) - 1 \right)$, where I is the total current, I_0 is the saturation current, q is the electron charge, V is the terminal voltage, k is Boltzmann's constant and T is the absolute temperature. Diodes can be tested for polarity using a "multimeter" and can be fully investigated using a **curve tracer** which produces a plot of the diode's characteristic.

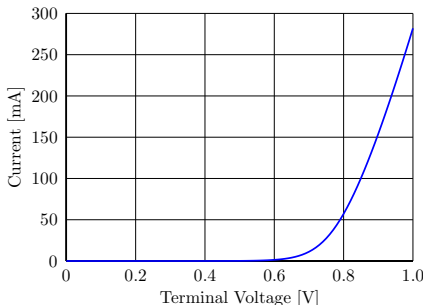
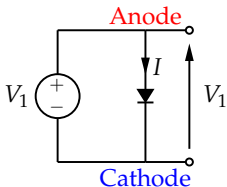

- When a positive voltage, V_1 , is applied to the p region (anode) with respect to the n region (cathode), the device is **forward biased** and a current, I , flows through the device.
- A certain value of applied **bias voltage** is necessary before an observable current flows, but once this value is reached, very small increases in applied voltage lead to exponential increases in current.
- For a **silicon diode** the current begins to increase when the applied voltage is $\approx 0.7 \text{ V}$.
- The voltage at which the current begins to rise is the **turn on voltage**. It is also called the **forward voltage drop**. It's an approximation, but a good one for most purposes.
- Turn on voltage is a function of band-gap. In other materials (specialist diodes, LEDs etc.) it could be higher or lower e.g. for a GaN “blue” LED it is $\sim 3 \text{ V}$.

The diode equation is difficult to use in circuit analysis. A **piecewise linear model** is preferable. The simplest practical model of a diode only addresses the direction of current flow.

First Linear Model

Assume that the diode conducts perfectly in the forward direction without any **voltage drop**. If the diode is **forward biased** the current flowing is limited only by the circuit elements surrounding it.

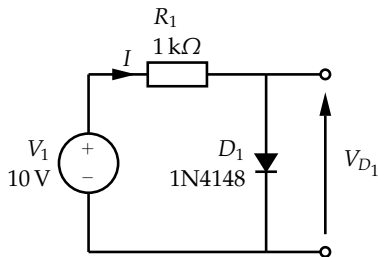
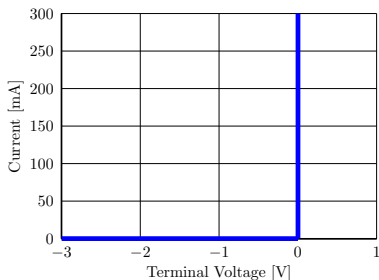

In this diode resistor circuit the resistor limits the current to 10 mA. In this model, the diode is incapable of dissipating power!

The simple model can be improved easily by the addition of a 0.7 V source to model the **turn on voltage** of the diode.

Improved Linear Model

Assume that the diode conducts perfectly in the forward direction with a constant **0.7 V drop**. If the diode is **forward biased** the current flowing is limited only by the circuit elements surrounding it.

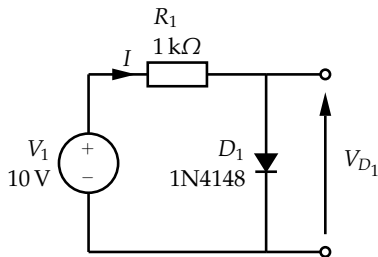
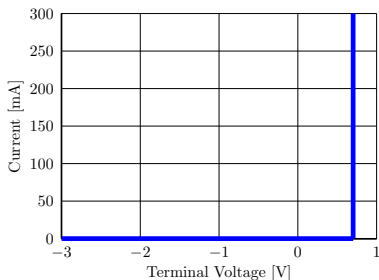

In this simple series diode resistor circuit the diode will limit the current to 9.3 mA. This improved model is often used.

Reverse Bias Characteristics

When the cathode voltage is greater than the anode the diode is **reverse biased**. The diode can be approximated by an open circuit. The current flowing is I_s - the **saturation** current. If the reverse bias voltage is sufficiently large *impact ionisation* occurs and the diode conducts a reverse current. This effect is used to produce **Zener diodes**. The maximum reverse voltage that can be sustained by a diode is the **repetitive reverse maximum** or **peak inverse voltage**.

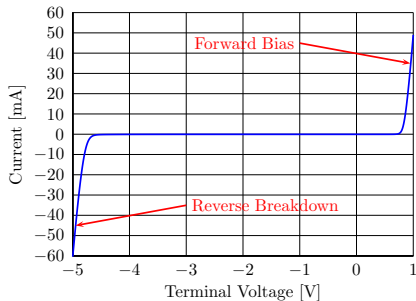

Conduction State Definitions

A diode in conduction

A diode is conducting if the magnitude of the current flowing in the diode is greater than zero. A diode ceases to be in a conducting state when the current falls to zero.

A diode on the point of conduction

A diode is on the point of conduction if the anode voltage is 0.7 V greater than the cathode. No current flows on the point of conduction.

The beginning of conduction

Conduction begins when the anode voltage is *more* than 0.7 V greater than the cathode.

A general method for deciding if a diode is conducting in any circuit is desirable.

General Method for Conduction State Problems

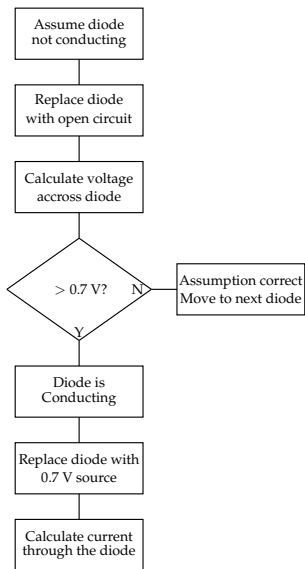

This flow diagram assumes the diode is not conducting. It is equally acceptable to assume that the diode is conducting and construct a slightly different flow diagram. In circuits containing more than one diode, the order in which they are analysed may be important. It is necessary to check that each prior diode every time one is found to change state.

Simple Conduction State Example

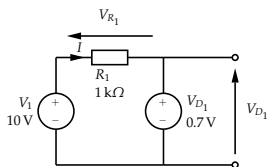
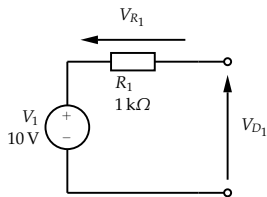
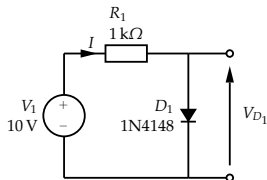

- 1 Assume the diode is not conducting.
- 2 Replace it with an open circuit. No current flows in R_1 and so no voltage is dropped across R_1 . Therefore all of V_1 appears across the diode (V_{D1}). The diode will enter conduction $V_{a-c} = 10 \text{ V}$, (> 0.7).
- 3 Replace the open circuit with a 0.7 V perfect voltage source. $V_{R1} = 10 - 0.7 = 9.3 \text{ V}$. By Ohm's law $I = 9.3 \text{ mA}$.

Example Question, Part A.

In the circuit below determine if the diode, D_1 , is conducting. If D_1 is conducting find the current, I_{D_1} flowing through it. If D_1 is not conducting find the magnitude of the reverse bias voltage across it.

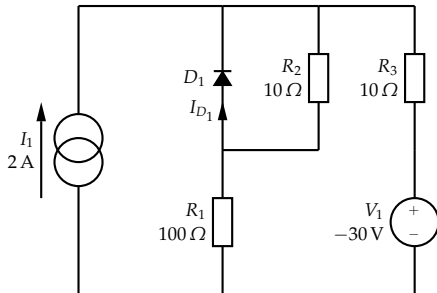

The node voltage and loop current methods and superposition theorem can be used. In this example Ohm's law and superposition will be used.

Follow the flow diagram in an earlier slide. Assume the diode is **not conducting** and is therefore replaced with an **open circuit**.

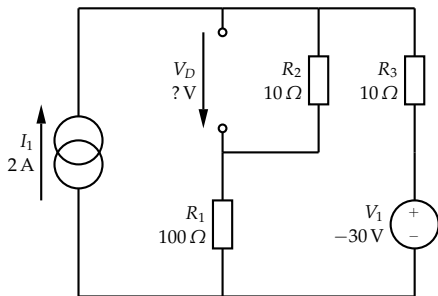

Use the **superposition theorem** to find the **voltage across this open circuit**. If the voltage is **greater than 0.7 V** then the non-conducting assumption is invalid. If the voltage is **less than 0.7 V** the non-conducting assumption is valid and we can state the **reverse bias voltage**. If the **voltage is exactly 0.7 V** the diode will be on the point of conduction and *no current will flow*.

Since **superposition** is being used, each of the **sources** must be **considered individually** and then their effects are combined. Choose to **consider the current source, I_1** , and **switch off the voltage source, V_1** . Replace it with a **short circuit**.

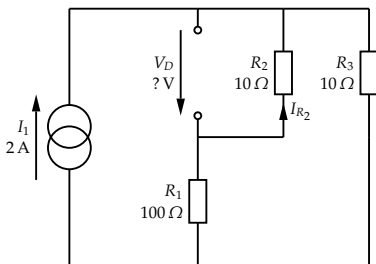

$$I_{R_2} = -I \cdot \frac{R_3}{R_1 + R_2 + R_3} \quad (1)$$

$$I_{R_2} = -2 \cdot \frac{10}{100 + 10 + 10} \quad (2)$$

$$I_{R_2} = -0.166\dot{6} \text{ A} \quad (3)$$

$$V_{R_2} = I_{R_2} \cdot R_2 \quad (4)$$

$$V_{R_2} = -1.66\dot{6} \text{ V} \quad (5)$$

Note that R_2 is in parallel with the open circuit. Note also that this is a **current divider** circuit and is analogous to a **potential divider**.

The **voltage source**, V_1 , which was previously replaced with a short circuit (its internal impedance) is **now considered alone**. The **current source** is replaced by an **open circuit** (its internal impedance).

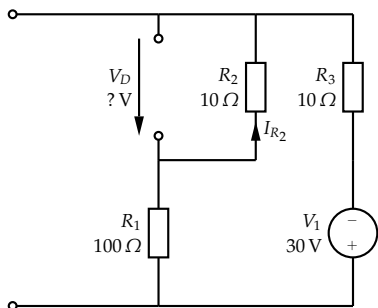

$$I_{R_2} = \frac{V_1}{R_1 + R_2 + R_3} \quad (6)$$

$$I_{R_2} = \frac{30}{100 + 10 + 10} \quad (7)$$

$$= 0.25 \text{ A} \quad (8)$$

$$V_{R_2} = I_{R_2} \cdot R_2 \quad (9)$$

$$V_{R_2} = 0.25 \cdot 10 = 2.5 \text{ V} \quad (10)$$

This is a potential divider circuit containing three resistors. The voltage is shared according to the magnitude of the resistances.

Summing the voltage across the open circuit due to both the current and voltage sources (I_1 & V_1) we have

$$V_D = 2.5 + (-1.66\bar{6}) = 0.83\bar{3} \text{ V.}$$

The assumption that the diode is not conducting is invalid!

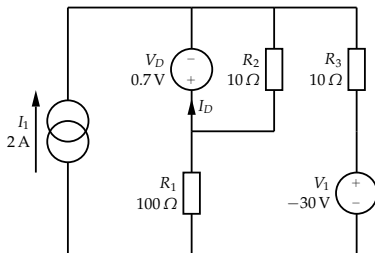

The open circuit must be replaced with a 0.7 V perfect voltage source. Each of the three sources (I_1 , V_1 and V_D) must be considered individually and superposition used to find the current, I_D , flowing in the forward biased diode.

Review

- Defined some terminology (Bias, Signals, Passive and Active components)
- Introduced Diodes as active components having a non linear relationship between voltage and current.
- Briefly considered how a diode is constructed from semiconducting materials
- Considered the effect of “forward” and “reverse” biasing a diode.
- Constructed two linear models of the diode action under forward bias.
- Defined three distinct states of conduction and non-conduction for a diode
- Provided a general method for solving conduction state problems in diode circuits.
- Started working through an example of a conduction state problem.

